

---

# **ComfoAir 160**

---



---

## **Installer manual**

---

All rights reserved.

This manual has been compiled with the utmost care. The publisher cannot be held liable for any damage caused as a result of missing or incorrect information in this manual. In case of disputes the Dutch version of these instructions will be binding.

# Table of Contents

Preface .....	1
<b>1 INTRODUCTION .....</b>	<b>1</b>
<b>1.1 Guarantee and liability .....</b>	<b>1</b>
1.1.1 Guarantee conditions .....	1
1.1.2 Liability .....	1
<b>1.2 Safety .....</b>	<b>2</b>
1.2.1 Safety regulations.....	2
1.2.2 Safety provisions and measures .....	2
1.2.3 Pictograms used .....	2
<b>2 FOR THE INSTALLER .....</b>	<b>3</b>
<b>2.1 ComfoAir configuration .....</b>	<b>3</b>
<b>2.2 Technical specifications .....</b>	<b>4</b>
<b>2.3 Dimension sketch .....</b>	<b>6</b>
<b>2.4 Installation conditions .....</b>	<b>6</b>
<b>2.5 Installation of the ComfoAir .....</b>	<b>7</b>
2.5.1 Transport and unpacking.....	7
2.5.2 Checking the delivery .....	7
2.5.3 Rework Right to Left version .....	7
2.5.4 Connecting the power cord.....	7
<b>2.6 Mounting of the ComfoAir .....</b>	<b>8</b>
2.6.1 Mounting on the ceiling .....	8
2.6.2 Mounting on the wall .....	8
2.6.3 Connection of the air ducts .....	9
2.6.4 Connection of the condensation drain .....	9
<b>2.7 Commissioning the ComfoAir .....</b>	<b>10</b>
2.7.1 Display on the unit.....	10
2.7.2 P menus for the user .....	11
2.7.3 P menus for the installer.....	13
<b>2.8 Programming air specifications .....</b>	<b>17</b>
<b>2.9 Maintenance by the installer .....</b>	<b>18</b>
2.9.1 Inspecting and cleaning the heat exchanger.....	18
2.9.2 Inspecting and cleaning the fans.....	19
<b>2.10 Malfunctions .....</b>	<b>19</b>
2.10.1 Malfunction alerts on digital operating devices.....	19
2.10.2 3-position switches with malfunction indicator .....	19
2.10.3 What to do in the event of a malfunction / Trouble shooting .....	20
2.10.4 Malfunctions (or problems) without alarms .....	28
<b>2.11 Service parts.....</b>	<b>29</b>
<b>2.12 Wiring diagram: ComfoAir 160 .....</b>	<b>30</b>
<b>2.13 EEC declaration of conformity .....</b>	<b>31</b>



## Preface



Carefully read this manual before use.

This manual provides all the information required for safe and optimal installation and maintenance of the ComfoAir 160. It is also intended as a reference for servicing, so that this can be carried out in a responsible manner. The device is subject to continuous development and improvement. As a result, the ComfoAir 160 may slightly differ from the descriptions.

---

### NOTE

*This manual has been compiled with the utmost care. However, no rights can be derived from it. In addition, we at all times reserve the right to change the contents of this manual, without prior notice.*

---

## 1 Introduction

The device's name is ComfoAir 160. In the following it will be referred to as ComfoAir.

The ComfoAir is a balanced ventilation system with heat recovery in order to create healthy, balanced and energy-efficient ventilation in houses. The ComfoAir has a CE marking on the identification plate. The identification plate can be found on top of the ComfoAir.

## 1.1 Warranty and liability

### 1.1.1 Guarantee conditions

The ComfoAir is covered by a manufacturer's warranty for a period of 24 months after fitting up to a maximum of 30 months after the date of manufacture. Warranty claims may only be submitted for material faults and/or construction faults arising during the warranty period. In the case of a warranty claim, the ComfoAir must not be dismantled without written permission from the manufacturer. Spare parts are only covered by guarantee, if they were supplied by the manufacturer and have been installed by an approved installer.

#### **The warranty becomes invalid if:**

- The guarantee period has elapsed;
- The device is used without filters;
- Parts are used that have not been supplied by the manufacturer;
- Non-authorized changes or modifications have been made to the unit.

### 1.1.2 Liability

The ComfoAir has been designed and manufactured for use in balanced ventilation systems incorporating Zehnder heat recovery systems. Any other application is seen as inappropriate use and can result in damage to the ComfoAir or personal injury, for which the manufacturer cannot be held liable.

The manufacturer is not liable for any damage originating from:

- Non-compliance with the safety, operating and maintenance instructions in this manual;
- The use of components not supplied or recommended by the manufacturer.  
Responsibility for the use of such components lies entirely with the installer;
- Normal wear and tear.

## 1.2 Safety

### 1.2.1 Safety regulations

Always comply with safety regulations in this manual. Non-compliance with the safety regulations, warnings, notes and instructions in this manual can cause personal injury or damage to the ComfoAir.

- The ComfoAir may only be installed, connected, rendered operational and maintained by an appropriately approved installer, unless otherwise indicated in this manual;
- Installation of the ComfoAir must be carried out in accordance with the general and locally applicable construction, safety and installation instructions of the local council, electricity and water boards or other agencies;
- Observe the safety regulations, warnings, comments and instructions as prescribed in this manual at all times;
- Keep this manual with the ComfoAir throughout its life;
- Instructions with regard to cleaning or replacing the filters of the intake and exhaust valves must be carefully observed;
- The specifications stated in this document may not be changed;
- The ComfoAir is only suitable for connection to 230V 50Hz mains;
- It is recommended to take out a maintenance contract so that the device is checked on a regular basis. The supplier can provide a list of registered installers nearby.

### 1.2.2 Safety provisions and measures

- The ComfoAir cannot be opened without using tools;
- It should not be possible to touch the fans, therefore ducting must be connected to the ComfoAir at a minimum duct length of 900mm.

### 1.2.3 Pictograms used

The following pictograms are used in this manual:



**Point of attention.**



**Risk of:**

- **damage to the device;**
- **performance of the device is compromised if instructions are not observed carefully.**



**Risk of personal injury to the user or installer.**

## 2 For the Installer

### 2.1 ComfoAir configuration

The standard ComfoAir configuration consists of:

- External casing (A) of coated sheeting;
- Interior (B) of EPP;
- 4 connections of EPP (C) for the air ducts;
- 2 filters (D) for air purification; Type G4 for outside air and type G4 for return air;
- 2 energy-efficient DC motors (E) with high-efficient fan and constant volume;
- HE (High Efficient) heat exchanger (F);
- Connector panel (L) with connections for the ComfoSense, the enthalpy exchanger and the two 0 -10 V controls;
- Electronic box with PCB panel (H) with connections for the fans, the bypass temperature sensors (T1 to T4), the 3-position switch with or without malfunction and filter indication (optional) and the bathroom switch (optional);
- Identification plate (I) detailing information on the ComfoAir (not visible);
- Condensation drain (J) to drain the condensation of the warm return air;
- Sticker (K) detailing the air connections (not visible);
- Display (G) to read data, and for programming procedures;
- 2 Filtercaps (M);
- 2 Mounting brackets (not visible).

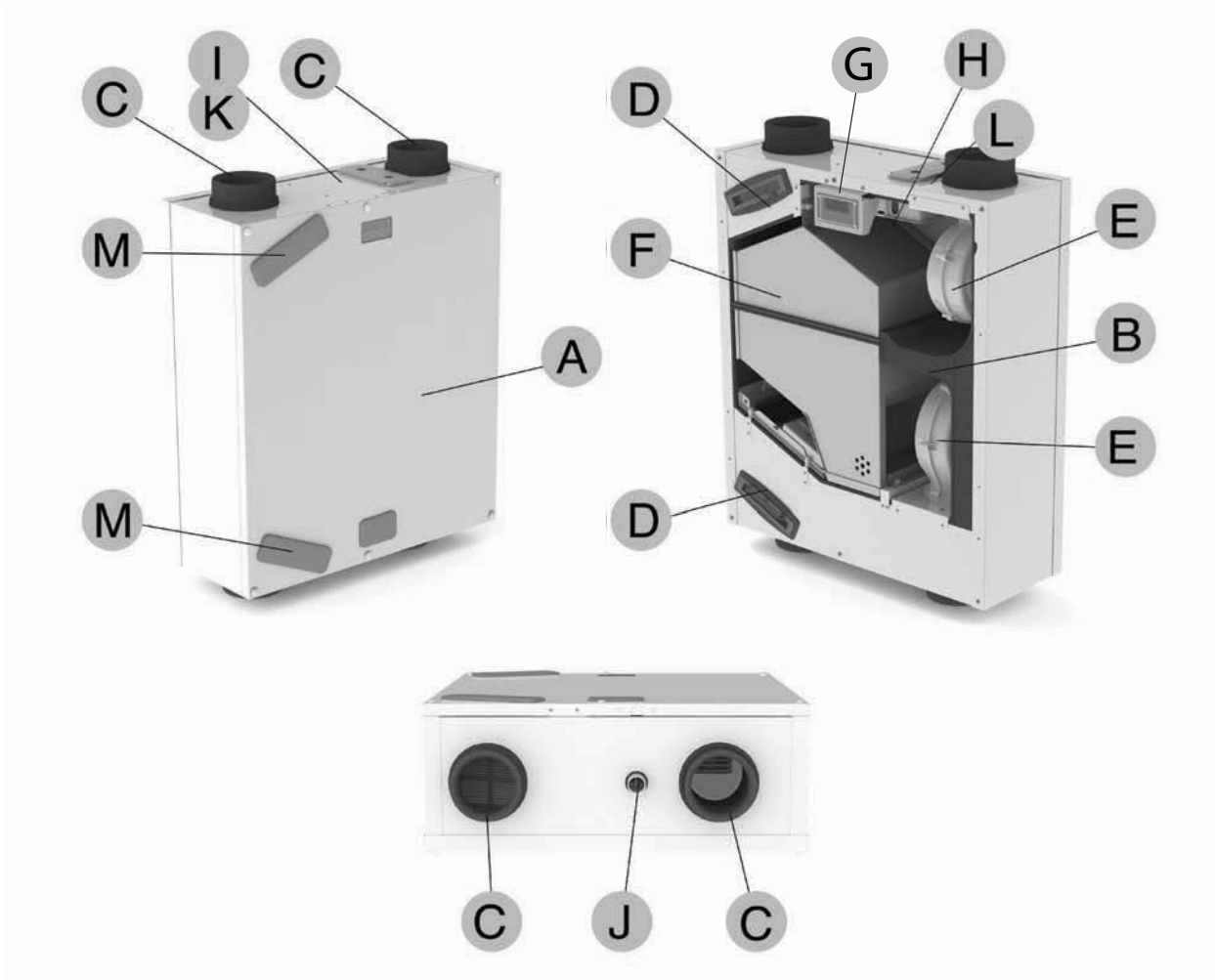

## 2.2 Technical specifications

### ComfoAir 160 nL (normal air volumes)

Position	Ventilation capacity	Power
ABSENT SETTING	29 m <sup>3</sup> /h at 4 Pa	10 W
LOW SETTING	57 m <sup>3</sup> /h at 14 Pa	14 W
MEDIUM SETTING	77 m <sup>3</sup> /h at 27 Pa	19 W
HIGH SETTING	112 m <sup>3</sup> /h at 57 Pa	32 W
MAXIMUM	157 m <sup>3</sup> /h at 110 Pa	67 W
Position	Ventilation capacity	Current
ABSENT SETTING	29 m <sup>3</sup> /h at 4 Pa	0,08 A
LOW SETTING	57 m <sup>3</sup> /h at 14 Pa	0,11 A
MEDIUM SETTING	77 m <sup>3</sup> /h at 27 Pa	0,15 A
HIGH SETTING	112 m <sup>3</sup> /h at 57 Pa	0,25 A
MAXIMUM	157 m <sup>3</sup> /h at 110 Pa	0,52 A

Electricity	
Power supply	230/50 V/Hz
Cos.phi	0,52 - 0,56

### Supply fan noise level (at 0 m)

Position	Ventilation capacity	Sound power
ABSENT SETTING	29 m <sup>3</sup> /h at 4 Pa	42 dB(A)
LOW SETTING	57 m <sup>3</sup> /h at 14 Pa	49 dB(A)
MEDIUM SETTING	77 m <sup>3</sup> /h at 27 Pa	55 dB(A)
HIGH SETTING	112 m <sup>3</sup> /h at 57 Pa	62 dB(A)
MAXIMUM	157 m <sup>3</sup> /h at 110 Pa	69 dB(A)

### Exhaust fan noise level (at 0 m)

Position	Ventilation capacity	Sound power
ABSENT SETTING	29 m <sup>3</sup> /h at 4 Pa	27 dB(A)
LOW SETTING	57 m <sup>3</sup> /h at 14 Pa	34 dB(A)
MEDIUM SETTING	77 m <sup>3</sup> /h at 27 Pa	39 dB(A)
HIGH SETTING	112 m <sup>3</sup> /h at 57 Pa	45 dB(A)
MAXIMUM	157 m <sup>3</sup> /h at 110 Pa	52 dB(A)



**ComfoAir 160 HL (high air volumes)**

Position	Ventilation capacity	Power
ABSENT SETTING	29 m <sup>3</sup> /h at 4 Pa	10 W
LOW SETTING	66 m <sup>3</sup> /h at 19 Pa	16 W
MEDIUM SETTING	113 m <sup>3</sup> /h at 56 Pa	32 W
HIGH SETTING	144 m <sup>3</sup> /h at 93 Pa	56 W
MAXIMUM	157 m <sup>3</sup> /h at 110 Pa	67 W
Position	Ventilation capacity	Current
ABSENT SETTING	29 m <sup>3</sup> /h at 4 Pa	0,08 A
LOW SETTING	66 m <sup>3</sup> /h at 19 Pa	0,13 A
MEDIUM SETTING	113 m <sup>3</sup> /h at 56 Pa	0,25 A
HIGH SETTING	144 m <sup>3</sup> /h at 93 Pa	0,44 A
MAXIMUM	157 m <sup>3</sup> /h at 110 Pa	0,52 A

**Electricity**

Power supply	230/50 V/Hz
Cos.phi	0,52 - 0,56

**Supply fan noise level (at 0 m)**

Position	Ventilation capacity	Sound power
ABSENT SETTING	29 m <sup>3</sup> /h at 4 Pa	42 dB(A)
LOW SETTING	66 m <sup>3</sup> /h at 19 Pa	51 dB(A)
MEDIUM SETTING	113 m <sup>3</sup> /h at 56 Pa	62 dB(A)
HIGH SETTING	144 m <sup>3</sup> /h at 93 Pa	67 dB(A)
MAXIMUM	157 m <sup>3</sup> /h at 110 Pa	69 dB(A)

**Exhaust fan noise level (at 0 m)**

Position	Ventilation capacity	Sound power
ABSENT SETTING	29 m <sup>3</sup> /h at 4 Pa	27 dB(A)
LOW SETTING	66 m <sup>3</sup> /h at 19 Pa	36 dB(A)
MEDIUM SETTING	113 m <sup>3</sup> /h at 56 Pa	45 dB(A)
HIGH SETTING	144 m <sup>3</sup> /h at 93 Pa	51 dB(A)
MAXIMUM	157 m <sup>3</sup> /h at 110 Pa	52 dB(A)

**General Specifications**

HE Exchanger Material	Polystyrene
Material Enthalpy exchanger	Polystyrene, Polyethylene + Polyether Copolymer
Interior Material	EPP
Thermal Yield	95%
Mass	28 kg

## 2.3 Dimension sketch

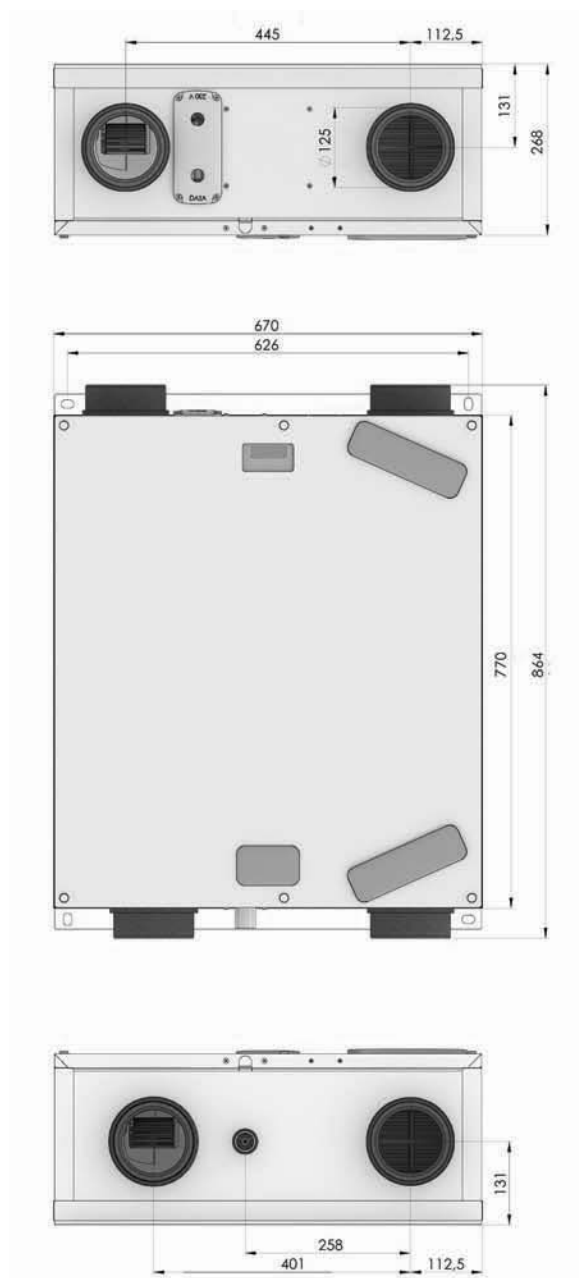

## 2.4 Installation conditions

In order to determine whether the ComfoAir can be installed in a certain area, the following aspects must be taken into account:

- The ComfoAir must be installed according to the general and locally applicable safety and installation regulations of power and water companies, as well as the instructions in this manual.
- The system must be fitted to allow sufficient room around the ComfoAir for the air connections and supply and exhaust ducts as well as for carrying out maintenance activities.
- The ComfoAir must be installed in a frost-free space. The condensation must be drained off frost-free, at a gradient and incorporate a 'U' bend.

 **Condensation may form on the outside of the ComfoAir if the unit is fitted in a space with higher average humidity levels (such as a bathroom, shower, toilet or kitchen). This is not a problem for the ComfoAir.**

- The room must offer the following provisions:
  - Air duct connections.
  - 230V electrical connection.
  - Provisions for the condensation drain.
  - Wiring for an wired 3-position switch (optional).
- A gap should be left near the doors in order to ensure effective and draughtfree airflow in the house. A gap under the inside doors must be at least 10mm.

 **If these openings are obstructed, due to draught excluders or deep-pile carpet, the airflow in the house will stagnate. As a result, system performance will be compromised or fail altogether.**

## 2.5 Installation of the ComfoAir

### 2.5.1 Transport and unpacking

Take the necessary precautions when transporting and unpacking the ComfoAir.

 **Make sure the packing material is disposed of in an environmentally friendly manner.**

### 2.5.2 Checking the delivery

Contact your supplier immediately in case of damage or an incomplete delivery. The delivery must include:

- ComfoAir with 2 mounting brackets installed. Check the identification plate to ensure that it is the required type;
- Documentation.

The ComfoAir is supplied in the following types:

Type
ComfoAir 160 Basic R
ComfoAir 160 Basic R ERV
ComfoAir 160 Basic R VV
ComfoAir 160 R Luxe
ComfoAir 160 R Luxe ERV
ComfoAir 160 R Luxe VV

Meaning of the suffixes:

- \* R = Right version
  - \* VV = Contains a preheater element by default.
  - \* ERV = Contains a enthalpy exchanger by default.
- ComfoSense panel (optional) can be ordered separately.

### 2.5.3 Rework Right to Left version

1. Remove the front panel by first removing the 6 protective caps (A) then the screws.
2. Remove the protection cap in the bottom of the front panel (B).
3. Place the removed protection cap in the old display hole.
4. Push out the foam behind the new gap and place it behind the moved protection cap.

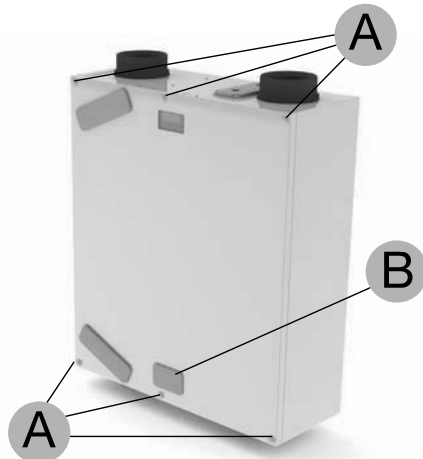

5. Release the back panel and the mounting brackets by unscrewing the 4 screws.
6. Remove the cover of the electronic box by pressing in the 2 click connectors (C).
7. Remove the display connector from the control PCB.
8. Release the display by unscrewing the 2 screws (D)

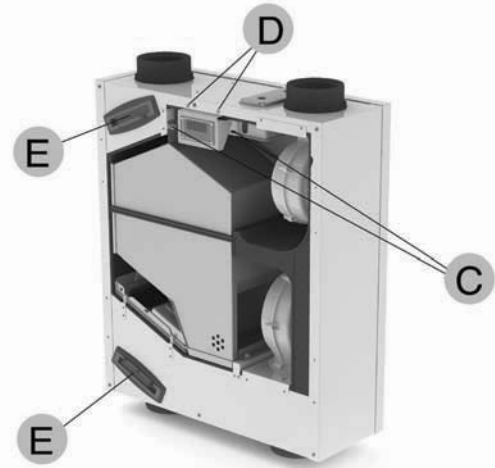

9. Place the removed display on the back side of the ComfoAir.
10. Connect the display connector again.
11. Place the cover of the electronic box back.
12. Remove the 2 filters (E) from the ComfoAir.
13. Place the back panel and the mounting brackets on the old front side.
14. Place the removed filters in the new front side of the ComfoAir.
15. Place the front panel on the old back side.

### 2.5.4 Connecting the power cord

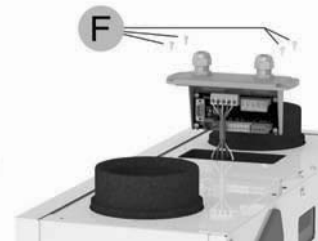

1. Release the electronic cover by unscrewing the 4 screws (F).
2. Carefully pull up the electronic cover
3. Pull the power cord thru the hole marked "230V".
4. Connect the Green/Yellow wire to the connector marked "⊥"

 **Make sure the earth wire (Green/Yellow) is at least 40 mm longer than the other connected wires.**

5. Connect the Blue wire to the connector marked "N".
6. Connect the Brown wire to the connector marked "L".
7. When present connect the Black wire to the connector marked "M".
8. When present connect the Gray wire to the connector marked "H".
9. Carefully place the electronic cover back.
10. Fasten the electronic cover with the 4 removed screws.

## 2.6 Mounting of the ComfoAir

The ComfoAir can be mounted two ways:

- On the ceiling;
- On the wall.

### 2.6.1 Mounting on the ceiling

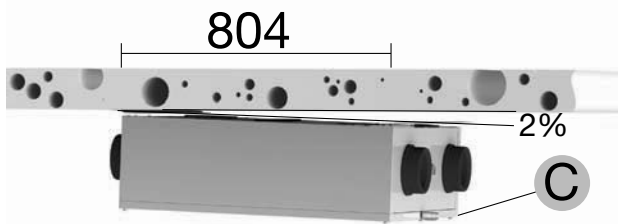

Mount the ComfoAir to a ceiling with a minimum mass of at least 200 kg/m<sup>2</sup>.

1. Seal off the existing condensation drain.
2. Remove the front panel by first removing the 6 protective caps (A) then the screws.

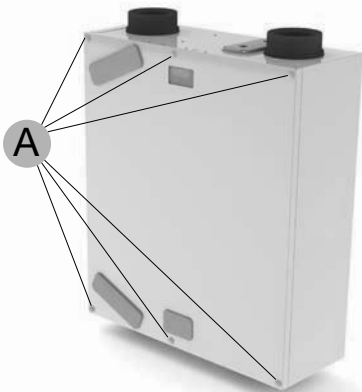

3. Remove the metal cover at the lower edge behind the front panel by removing the two screws.
4. Remove the pre-punched section for the condensation drain from the foam in the front panel.
5. Remove the aluminium tape (B).



6. Fit the special flat condensation drain (1 screw in the centre) over the holes in the exchanger. The flat condensation drain is available on request from Zehnder.

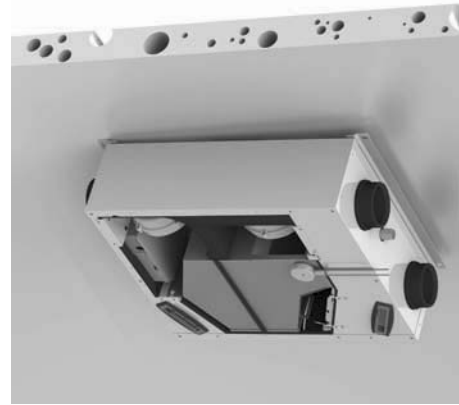

7. Refit the front panel.
8. Mark the position of the mounting points on the ceiling.

**⚠ Allow a 2% run-off to the condensation drain (C).**

9. Fix the ComfoAir to the ceiling.
10. Fit the condensation drain to the new connector.

**Ensure** that there is enough room under the ComfoAir for carrying out maintenance. The ComfoAir does not require any space at the sides for effective operation.

**👉 Do not mount the side of the ComfoAir against the wall due to the risk of impact sound.**

### 2.6.2 Mounting on the wall

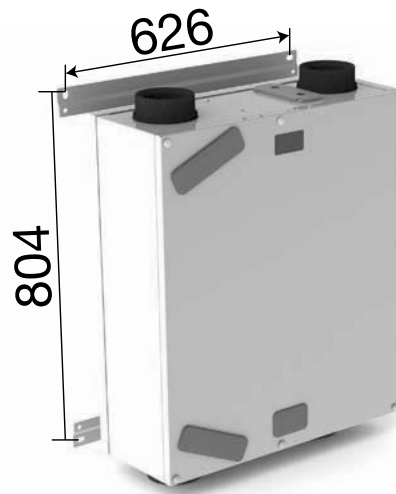

Mount the ComfoAir against a wall with a minimum mass of 200 kg/m<sup>2</sup>.

1. Using a spirit level, fix the mounting bracket horizontally to the wall. Make sure there is enough space under the ComfoAir to mount the siphon.
2. Mount the ComfoAir on the wall.
3. Mount the condensation drain under the ComfoAir.

Make sure to leave a minimum space of 1 metre in front of the ComfoAir for carrying out maintenance. The ComfoAir does not require any space at the sides for effective operation.

**👉 Do not mount the side of the ComfoAir against the wall due to the risk of impact sound.**

### 2.6.3 Connection of the air ducts

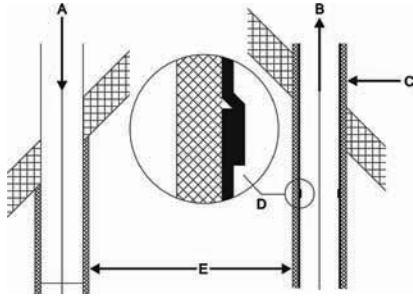

The following aspects must be taken into account, while installing the air ducts:

- **Install** the air exhaust duct so it drains in the direction of the ComfoAir.
- **Insulate** the outside air supply and the air exhaust duct between the roof/wall passage to render the ComfoAir damp proof. This prevents the formation of condensation on the outside of the ducts.
- To prevent unnecessary temperature loss in either the summer or the winter, we recommend fitting thermal and damp-proof insulation to the supply ducts from the ComfoAir up to the supply valves.
- Install the air ducts with a minimum  $\varnothing$  of 125 mm, as little air resistance as possible and free from air leakage.
- Install a silencer of at least 1m straight directly onto the supply and return airconnections. For relevant advice, please contact Zehnder.
- When using flexible channels only Zehnder channel systems may be used. Any other flexible channel will disturb the basic operating principle of the balanced ventilation system.
- We recommend that the ventilation system is fitted with intake and exhaust valves made by Zehnder.
- We recommend that the ventilation system is fitted with a non-powered extractor hood made by Zehnder.

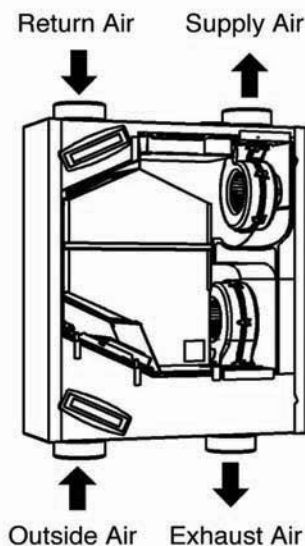

ComfoAir 160 - Right

### 2.6.4 Connection of the condensation drain

#### Standard heat exchanger

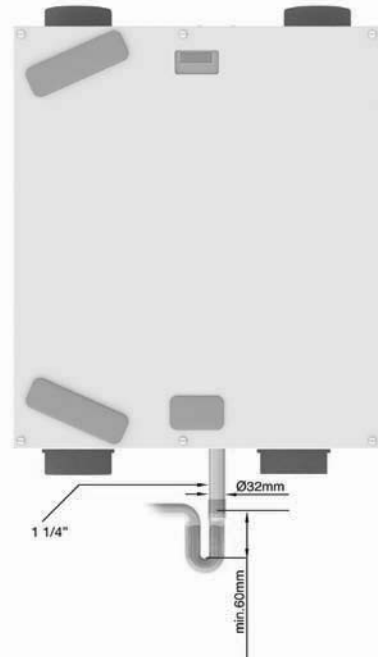

ComfoAir - Right

Warm exhaust air is cooled by the outside air in the heat exchanger. This causes the moisture in the indoor air to condense in the heat exchanger. The condensation water created in the heat exchanger is fed to a PVC condensation drain.

The connection for the condensation drain has an external diameter of 32 mm. It is located underneath the ComfoAir.

- **Connect** the condensation drain, via a pipe with coupling or hose, to the water seal (siphon) of the domestic waste-water system.
- Make sure that the outer end of the pipe or tube exits is at least 60mm below the water level.
- Ensure the condensation drain pipe on ceiling-mounted units has a run-off to the U bend, of at least 2%.

**⚠ Ensure that the water seal connected to the domestic waste-water system is always full of water. This prevents the ComfoAir from sucking in any leakage air.**

#### Enthalpy exchanger

When the ComfoAir is fitted with an enthalpy exchanger the humidity from the extracted air is partly transferred to the fresh supply air. In this case you delay the process of drying out the house in dry winter months, additionally there is no condensate that must be drained from the ComfoAir. Therefore a condensation drain is not necessary with an enthalpy exchanger.

**⚠ Ensure that the condensation drain is sealed. This prevents the ComfoAir from sucking in any leakage air.**

The condensation drain can be sealed with a standard screw-cap.

## 2.7 Commissioning the ComfoAir

After installation, the ComfoAir must be commissioned.

This can be done via the P menus on the digital operating device. These P menus can be used to enter various settings (ventilation programmes, in particular) for the ComfoAir. An overview of the available P menus is given below:

Menu	Options
P1	Reading statuses (from menu P2)
P2	Setting time delays
P3	Setting and reading the ventilation levels
P4	Setting and reading the temperatures
P5	Setting additional programmes
P6	Setting additional programmes
P7	Reading and resetting malfunctions (and system information)
P8	Setting the RF input
P9	Reading statuses (from menu P5 and P6)





P menus P1, P2 and P9 can be accessed by the user, mainly to read statuses and set time delays. The remaining P menus P3 to P8 are intended **solely** for the installer.

 **After a power cut, the bypass and Preheater element valves will automatically search for the correct position. It may be that the valves move a few times so the correct position can be determined.**

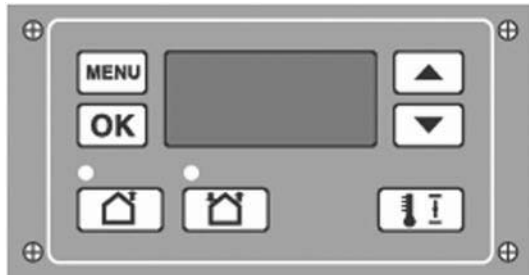
### 2.7.1 Display on the unit

The ComfoAir can be operated and commissioned by means of a display. The display is a digital operating device which is mounted on the ComfoAir.



<b>MENU</b>	select menu		up
<b>OK</b>	OK		down
	supply off (led green)		supply on (led green)
	comfort temperature		

Shown in display

<b>A</b>	Ventilation setting absent
<b>1</b>	Ventilation setting low
<b>2</b>	Ventilation setting medium
<b>3</b>	Ventilation setting high
<b>X X</b>	Menu symbol
<b>X X</b>	Malfunction code (flashes)
<b>•</b>	Bypass

### Access to the menus

Sequence	Press	Display	Description
1	MENU	P2	Time delay
2	<b>▲ + ▼</b> (3 seconds)	P3	Press the buttons simultaneously.
3	<b>▲</b>	P4	Temperatures
4	<b>▲</b>	P5	Settings
5	<b>▲</b>	P6	Settings
6	<b>▲</b>	P7	Malfunction / Reset / Self-test
7	<b>▲</b>	P8	0 - 10V Inputs
8	<b>▲</b>	P9	Status

### Example

Setting the MEDIUM POSITION of the supply fan to 40%.

Sequence	Press	Display	Description
1	MENU	P2	Time delay
2	<b>▲ + ▼</b> (3 seconds)	P3	Press the buttons simultaneously.
3	OK	P30	Exhaust fan Position A
4	<b>▲ (6x)</b>	P36	Select P36
5	OK	50	Current setting
6	<b>▼ (10 x or press continuously)</b>	40	Select 40
7	OK	P36	Value is 40
8	MENU	P3	
9	MENU	1	Fan setting

 **Some P menus (such as P1 and P9) can only be read.**

### Leaving Reading menu

- At action point 6 press "MENU" (instead of "OK").

 **The display can not be used for setting the ventilation positions of the ComfoAir. The arrowkeys are only for setting the additional programmes.**

## 2.7.2 P menus for the user

### Menu P1 → Status of programmes

Sub-menu	Description	Status
		Activated
P11	Is menu 21 currently active?	Yes (1) / No (0)
P12	Is menu 22 currently active?	Yes (1) / No (0)
P13	Is menu 23 currently active?	Yes (1) / No (0)
P14	Is menu 24 currently active?	Yes (1) / No (0)
P15	Is menu 25 currently active?	Yes (1) / No (0)
P16	Is menu 26 currently active?	Yes (1) / No (0)

### Menu P2 → Setting time delays

Sub-menu	Description	Time delay values		
		Mini- mum	Maxi- mum	General Reset
P21 (Optional)  <b>Note:</b> <b>Only applies to systems fitted with a corded switch and a second switch in the bathroom.</b>	Delay timer for the bathroom switch (to switch to high position). <ul style="list-style-type: none"> <li>'x' minutes after operating the bathroom switch, the ComfoAir switches to the HIGH SETTING.</li> </ul> - Low voltage input	0 Min.	15 Min.	0 Min.
P22 (Optional)  <b>Note:</b> <b>Only applies to systems fitted with a corded switch and a second switch in the bathroom.</b>	Overrun timer for the bathroom switch (to switch to normal position). <ul style="list-style-type: none"> <li>'x' minutes after operating the bathroom switch, the ComfoAir switches back to the NORMAL SETTING.</li> </ul> - Low voltage input	0 Min.	120 Min.	30 Min.
P23 (Optional)  <b>Note:</b> <b>Only applies to systems fitted with a hardwired 3-position switch.</b>	Overrun timer for ventilation position 3 (using an wired 3-position switch). <ul style="list-style-type: none"> <li>If ventilation setting 3 (high) is switched on briefly (&lt; 3 sec), the ComfoAir will switch to the HIGH SETTING for 'x' minutes and then automatically returns to the NORMAL SETTING.</li> </ul> If any 3-position switch is operated during this lagging time the ComfoAir will instantly revert to the ventilation position as set at that time.	0 Min.	120 Min.	0 Min.
P24	Filter warning <ul style="list-style-type: none"> <li>'x' weeks after cleaning the filters the "FILTER DIRTY" alert will reappear.</li> </ul>	10 weeks	26 weeks	16 weeks
P25  <b>Note:</b> <b>Only applies to systems fitted with an RF switch.</b>	Overrun timer for ventilation setting 3 (using "☺"). <ul style="list-style-type: none"> <li>After pressing "☺" briefly (&lt; 2 sec.), the ComfoAir will switch to the HIGH setting for 'x' minutes and then automatically returns to the NORMAL setting.</li> </ul> If any 3-position switch is operated during this lagging time the ComfoAir will instantly revert to the ventilation position as set at that time.	1 Min.	20 Min.	10 Min.

Sub-menu	Description	Time delay values		
		Minimum	Maximum	General Reset
P26  <b>Note:</b> <b>Only applies to systems fitted with an RF switch.</b>	<p>Overrun timer for ventilation setting 3 " using ☺ ".</p> <ul style="list-style-type: none"> <li>After pressing " ☺ " CONTINUOUSLY (&gt; 2 sec.), the ComfoAir will switch to the HIGH setting for 'x' minutes and then automatically returns to the NORMAL setting.</li> </ul> <p>If any 3-position switch is operated during this lagging time the ComfoAir will instantly revert to the ventilation position as set at that time.</p>	1 Min.	120 Min.	30 Min.
P27  <b>Note:</b> <b>Only applies to systems fitted with a ComfoSense panel.</b>	<p>Time for the Boost setting.</p> <ul style="list-style-type: none"> <li>After turning on the PARTY TIMER on the ComfoSense panel, the ComfoAir will switch to the high setting for 'x' minutes and then automatically returns tot the NORMAL setting</li> </ul> <p>If any 3-position switch is operated during this lagging time the ComfoAir will instantly revert to the ventilation position as set at that time.</p>	0 Min.	120 Min.	30 Min.

### **Menu P9 → Status of programmes (from menu P5 and P6 additional programmes)**

Sub-menu	Description	Status
		Activated
P90	Open fire programme active?	Yes (1) / No (0)
P91	Bypass Open?	Yes (1) / No (0)
P94	n/a	Yes (1) / No (0)
P95	Frost protection active?	Yes (1) / No (0)
P97	Enthalpy programme active?	Yes (1) / No (0)



### 2.7.3 P menus for the installer

 *Menus with a line at minimum and maximum value are Reading menus.*





#### **Menu P3 → Setting ventilation programmes**

Submenu	Description	Ventilation programme values		
		Minimum	Maximum	General Reset
P30	Setting the capacity (in %) of the exhaust fan in ABSENT POSITION.	0% or 15%	97%	nL / HL 15% / 15%
P31	Setting the capacity (in %) of the exhaust fan in LOW POSITION.	16%	98%	nL / HL 35% / 40%
P32	Setting the capacity (in %) of the exhaust fan in MEDIUM POSITION.	17%	99%	nL / HL 50% / 70%
P33	Setting the capacity (in %) of the exhaust fan to HIGH POSITION.	18%	100%	nL / HL 70% / 90%
P34	Setting the capacity (in %) of the supply fan to ABSENT POSITION.	0% or 15%	97%	nL / HL 15% / 15%
P35	Setting the capacity (in %) of the supply fan in LOW POSITION.	16%	98%	nL / HL 35% / 40%
P36	Setting the capacity (in %) of the supply fan in MEDIUM POSITION.	17%	99%	nL / HL 50% / 70%
P37	Setting the capacity (in %) of the supply fan in HIGH POSITION.	18%	100%	nL / HL 70% / 90%
P38	Current capacity (in %) of the exhaust fan.	-	-	Current %
P39	Current capacity (in %) of the supply fan.	-	-	Current %



#### **Menu P4 → Reading the temperatures**

Submenu	Description	Temperature values		
		Minimum	Maximum	General Reset
P41	Comfort temperature	12 °C	28 °C	20 °C
P45	Current value of T1 (= outside air temperature)	-	-	Current °C
P46	Current value of T2 (= supply air temperature)	-	-	Current °C
P47	Current value of T3 (= return air temperature)	-	-	Current °C
P48	Current value of T4 (= exhaust air temperature)	-	-	Current °C

## Menu P5 → Setting additional programmes

Submenu	Description	Additional programme values		
		Minimum	Maximum	General Reset
P50	Activation of the open fire programme.	0 (= No)	1 (= Yes)	0
P51	Confirming the presence of a Preheater element	0 (= No)	1 (= Yes)	0
	 <b>Only change if a preheater element is installed afterwards or a general reset is given.</b>			
P52	Setting the Preheater programme. <ul style="list-style-type: none"> <li>• 0; Best protection.</li> <li>• 1; High protection.</li> <li>• 2; Nominal protection.</li> <li>• 3; Economy.</li> </ul>	0	3	2
	 <b>In BEST PROTECTION MODE the Preheater element is switched on soonest; this level offers the best guarantee of balanced ventilation. Vice versa, in ECONOMY MODE the Preheater element switches on at the last possible moment; balanced ventilation is not guaranteed in this mode.</b> <p>When commissioning the ComfoAir, the Preheater programme can usually be left at level 2: NOMINAL MODE (factory setting). In areas with frequent cold spells in winter (frequent periods of -10°C or lower), level 1 should be selected: HIGH PROTECTION or even level 0: BEST PROTECTION.</p>			
P56	Setting the required air volume in the house. <ul style="list-style-type: none"> <li>• nL: "normal air volume".</li> <li>• HL: "high air volume".</li> </ul>	nL	HL	HL
	 <b>Setting the air volume is the starting point for programming the air specifications and setting the fans.</b>			
P58	n/a	0	1	0
P59	Confirming the presence of an enthalpy exchanger. <ul style="list-style-type: none"> <li>• 0; Enthalpy exchanger not fitted</li> <li>• 1; Enthalpy exchanger with enthalpy sensor.</li> <li>• 2; Enthalpy exchanger without enthalpy sensor.</li> </ul>	0 (= No)	2 (= Yes)	0
	 <b>Ensure the condensation drain is sealed.</b>			
	 <b>If an enthalpy exchanger without a sensor is selected, then the safety programme will not be activated and malfunction alerts EA1 &amp; EA2 will never occur.</b>			

## Menu P7 → Reading malfunctions (and system information)

Submenu	Description	(Malfunction) information values		
		Minimum	Maximum	General Reset
P70	Current software version.	Version number of the software (without "v")		
P71	Most recent malfunction.	Code in accordance with alarm and malfunction alert		
P72	Malfunction before the most recent one	Code in accordance with alarm and malfunction alert		
P73	Malfunction before the most recent two	Code in accordance with alarm and malfunction alert		
P74	Ressetting malfunction(s) <ul style="list-style-type: none"> <li>Set value tot '1' and press "OK" on the display or on the ComfoSense panel.</li> </ul>	0	1 (= activate)	0
P75	General reset. <ul style="list-style-type: none"> <li><b>Press "OK"</b> on the display or on the ComfoSense panel for at least 5 seconds to carry out a general reset. All original software settings are restored following a general reset.</li> </ul> <p><b>Note:</b></p> <p> <b>After a general reset, the ComfoAir will ask you to reset the "nL / HL" (see P56) settings.</b></p> <p> <b>Following a general reset, all settings and programmes need to be checked and set to the right value.</b></p>	0	1 (= activate)	0
P76	Self-testing the ComfoAir	0	1 (= activate)	0
	<p></p> <ul style="list-style-type: none"> <li>The LED's on the display will start blinking.</li> <li>The ComfoAir will run at maximum Rotation Per Minute (RPM).</li> <li>The bypass valve will open and close.</li> <li>The preheater valve will open and close after the bypass has closed (If a preheater element is fitted).</li> </ul>			
P77	Resetting filter dirty counter	0	1 (= activate)	0
	<p><b>Note:</b></p> <p>This resets the counter that triggers a dirty filter alert on the ComfoAir. This allows the filter to be cleaned or replaced before the dirty filter alert appears.</p>			

## Menu P8 → Setting the RF input and digital inputs (0-10V)

Submenu	Description	Analogue input values		
		Minimum	Maximum	General Reset
810	Analogue input 1 0= not fitted 1= fitted	0	1	0
811	0= controlling 1= programming (analogue input 1)	0	1	0
812	set point analogue input 1 (programming)	0	100	50
813	min. setting analogue input 1	0	99	0
814	max. setting analogue input 1	0	100	100
815	0=positive analogue input 1 1=negative setting analogue input 1	0	1	0
816	read-out analogue input 1	0	100	-
820	Analogue input 2 0= not fitted 1= fitted	0	1	0
821	0= controlling 1= programming (analogue input 2)	0	1	0
822	set point analogue input 2 (programming)	0	100	50
823	min. setting analogue input 2	0	99	0
824	max. setting analogue input 2	0	100	100
825	0=positive analogue input 2 1=negative setting analogue input 2	0	1	0
826	read-out analogue input 2	0	100	-
850	RF input 1 0= not fitted 1= fitted	0	1	0
851	0= controlling 1= programming (RF input 1)	0	1	0
852	set point RF input 1 (programming)	0	100	50
853	min. setting RF input 1	0	99	0
854	max. setting RF input 1	0	100	100
855	0=positive RF input 1 1=negative setting RF input 1	0	1	0
856	Read-out RF input	0	100	-

## 2.8 Programming air specifications

After installation, the ComfoAir must be programmed.

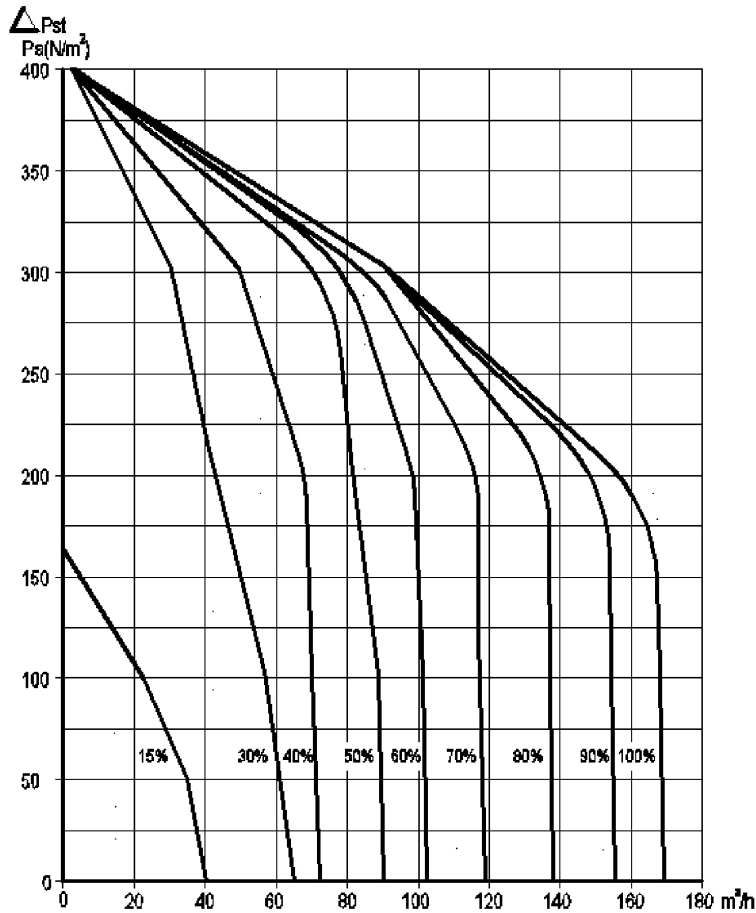

This can be done using the air specifications of the ComfoAir above.



The default settings of the ComfoAir nL are:

Position ABSENT	15%
Position LOW	35%
Position MEDIUM	50%
Position HIGH	70%

The default settings of the ComfoAir HL are:

Position ABSENT	15%
Position LOW	40%
Position MEDIUM	70%
Position HIGH	90%

Follow this procedure to programme the ComfoAir (after installation):

- Set the ComfoAir in programming mode.
  - Display: Press simultaneously for at least 3 seconds on " " and " " until "InR" appears on the display.
  - ComfoSense panel:
    - Drücken Sie auf OK. Im Display steht 8 Sekunden lang SHIFT.
    - Drücken Sie auf MENU, bevor der Text SHIFT wieder verschwindet. Im Display erscheint der Text COMF.
    - Drücken Sie auf oder auf und wählen Sie INIT.
    - Drücken Sie auf OK. Im Display blinkt der Text INIT ON.

- Bestätigen Sie mit OK. Im Display steht 2 Sekunden lang OK.
- Der Text INIT ist im Hauptfenster sichtbar.

 **In programming mode, the bypass and Pre-heater element valves are always closed. After 30 minutes, the ComfoAir automatically terminates the programming mode.**

- Close all windows and outside doors.
- Close all inside doors.
- Check the presence of structural overflow provisions.

 **The structural overflow provisions must be at least 12 cm<sup>2</sup> per l/s.**

- Check if both fans function in the three speed settings.
- Switch the ComfoAir to high speed.
- Install all valves and set the valves according to the settings given or as set in the reference house.



If no data are known:

- Install the valves and **open** them as far as possible.
- Measure the air volumes; starting with the intake air and then the exhaust air.
- If the measured air volumes deviate from the nominal air volumes by more than +/-10%,

and the majority of the deviations is positive, **ensure** that all deviations are positive. If the majority of all deviations is negative, **ensure** that all deviations are negative. **Ensure** that one supply valve and one exhaust continue to be fully open.

8. Change the fan settings in P menu P30 to P37 of the digital operating device.
  - Select the lowest possible setting in order to conserve energy.
  - Ensure that the ratios between low, medium and high remain equal.

 **Use the chart of the ComfoAir's air specifications to set the fans.**

9. In the event that the currently set air volumes still deviate too much: Adjust the valves.
10. Check the entire installation again, after all valves have been set.
11. Switch the ComfoAir (back) to ventilation position 2.
  - Display: Press simultaneously for 3 seconds on " and " until "InR" disappears of the display.
  - ComfoSense panel:
    - a. Drücken Sie auf OK. Im Display steht 8 Sekunden lang SHIFT.
    - b. Drücken Sie auf MENU, bevor der Text SHIFT wieder verschwindet. Im Display erscheint der Text COMF.
    - c. Drücken Sie auf oder auf und wählen Sie INIT.
    - d. Drücken Sie auf OK. Im Display blinkt der Text INIT ON.
    - e. Bestätigen Sie mit OK. Im Display steht 2 Sekunden lang OK.

## 2.9 Maintenance by the installer

The following maintenance must be carry out by the installer:

- Inspecting and (if necessary) cleaning the heat exchanger;
- Inspecting and (if necessary) cleaning the fans.

A concise explanation of these maintenance activities is given in the paragraphs below.

 **Check the condensation drain once every 2 years.**

 **Failure to carry out (periodic) maintenance on the ComfoAir ultimately compromises the performance of the ventilation system.**

### 2.9.1 Inspecting and cleaning the heat exchanger

 **Check the heat exchanger once every 2 years.**

1. Disconnect the power from the ComfoAir.
2. Remove the front panel by first removing the 6 protective caps (A) then the screws.

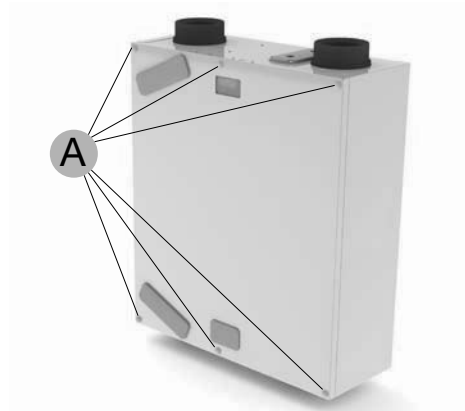

3. Remove the lower sensor (D) from its holder.
4. Remove the lower 2 M6 bolts (B).
5. Remove the loose splash screen.
6. Remove the remaining 3 M6 bolts (E) of the heat exchanger.
7. Remove the heat exchanger (C) from the unit.

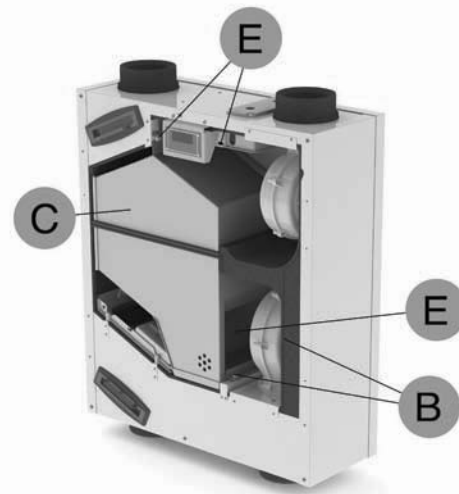

**The heat exchanger may fall downwards on ceiling-mounted units, so ensure it is fully supported.**

8. Inspecting and if necessary clean the heat exchanger.
  - Use a soft brush to clean the lamellae.
  - Use a vacuum cleaner or air gun (no high pressure) to remove dirt and dust.



**Always clean against the direction of the air-flow. This prevent dirt from getting stuck in the heat exchanger.**

- a. Submerge the heat exchanger several times in hot water (max. 40 °C).
- b. Rinse the heat exchanger with clean hot tap water (max. 40 °C).
- c. Clasp the heat exchanger between both hands (on the coloured side surfaces) and shake the water from the heat exchanger.



**Do not use aggressive cleaning agents or solvents.**



**If the fans also need maintenance do not re-**

**install the heat exchanger yet.**

- If no more maintenance is necessary install all parts in reverse order, reconnect the power and carry out the self-test in accordance with menu P76.



**Fasten the screws to a maximum of 1.5 Nm. This is roughly equal to speed 2 of an average battery-powered drill.**

## 2.9.2 Inspecting and cleaning the fans



**Check the fans once every 2 years.**

- Remove the heat exchanger as instructed in the maintenance chapter of the heat exchanger
- Pull out the black stop (D) next to the fan(s).
- Turn the fan(s) slightly.
- Slide the fan(s) out of the unit.
- Inspecting and if necessary clean the fans (O).
  - Use a soft brush to clean the fan impellers.
  - Use a vacuum cleaner to remove dust.



**Do not damage the fan impellers or temperature sensor.**

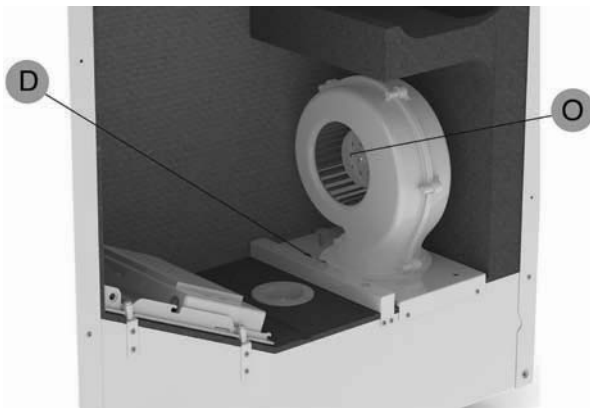

- Install all parts in reverse order.
- Carry out the self-test as per menu P76.



**Fasten the screws to a maximum of 1.5 Nm. This is roughly equal to speed 2 of an average battery-powered drill.**

## 2.10 Malfunctions

Malfunctions in the ComfoAir are reported as follows:

- The malfunction alert appears on the display.
- The malfunction alert appears on the ComfoSense panel;
- The malfunction indicator on the 3-position switch lights up;

Malfunction alerts may not appear on the digital operating device in all cases, even though there is a malfunction (or problem). A concise explanation of both types of malfunction (or problem) is given in the paragraphs below.

### 2.10.1 Malfunction alerts on the digital operating device

In the event of a malfunction, the corresponding malfunction code will be displayed on the digital operating device of the ComfoAir.

Below is a list of the malfunction alerts on the digital operating device.

In the chapter about trouble shooting is explained how to solve these malfunctions

Code	Description
A1	NTC sensor T1 is defective. (= outside air temperature)
A2	NTC sensor T2 is defective. (= supply air temperature)
A3	NTC sensor T3 is defective. (=return air temperature)
A4	NTC sensor T4 is defective. (= exhaust air temperature)
A5	Malfunction in the bypass motor.
A6	Malfunction in the Preheater element motor.
A7	Preheater element does not heat sufficiently.
A8	Preheater element becomes too hot
E1	Exhaust fan not rotating
E2	Supply fan not rotating.
EA1	Enthalpy sensor measures excessive Relative Humidity (RH) values.
EA2	No communication between the enthalpy sensor and the ComfoAir.
COMM ERROR	No communication between the ComfoSense panel and the ComfoAir.
,Fil',tEr'	Internal Filter is dirty.
FLTR	Internal Filter is dirty.

### 2.10.2 3-position switch with malfunction indicators

The 3-position switches that are fitted with a malfunction indicator show when a malfunction or filter dirty alert has occurred. Depending on the type of the 3-position switch, this is done in one of the following two ways:

- 3-position switch with malfunction indicator. In the event of a malfunction or filter dirty alert the indicator lights up;
- Wireless 3-position switch with malfunction indicator.

The malfunction indicators will light up once this 3-position switch is used. One indicator will light up green to indicate communication has been established. Subsequently, in the event of a malfunction or filter dirty alert both indicators will flash red 3 times. After that, both indicators will light up green once more.

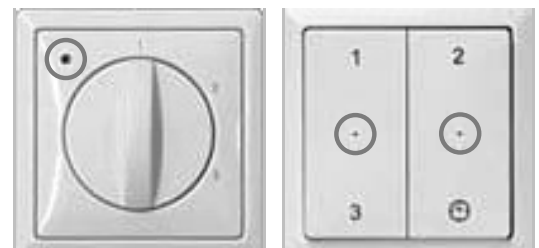

## 2.10.3 What to do in the event of a malfunction / Trouble shooting

Below are a number of trouble-shooting tips for the malfunction alerts described previously which can appear on the digital operating device in the event of a malfunction.

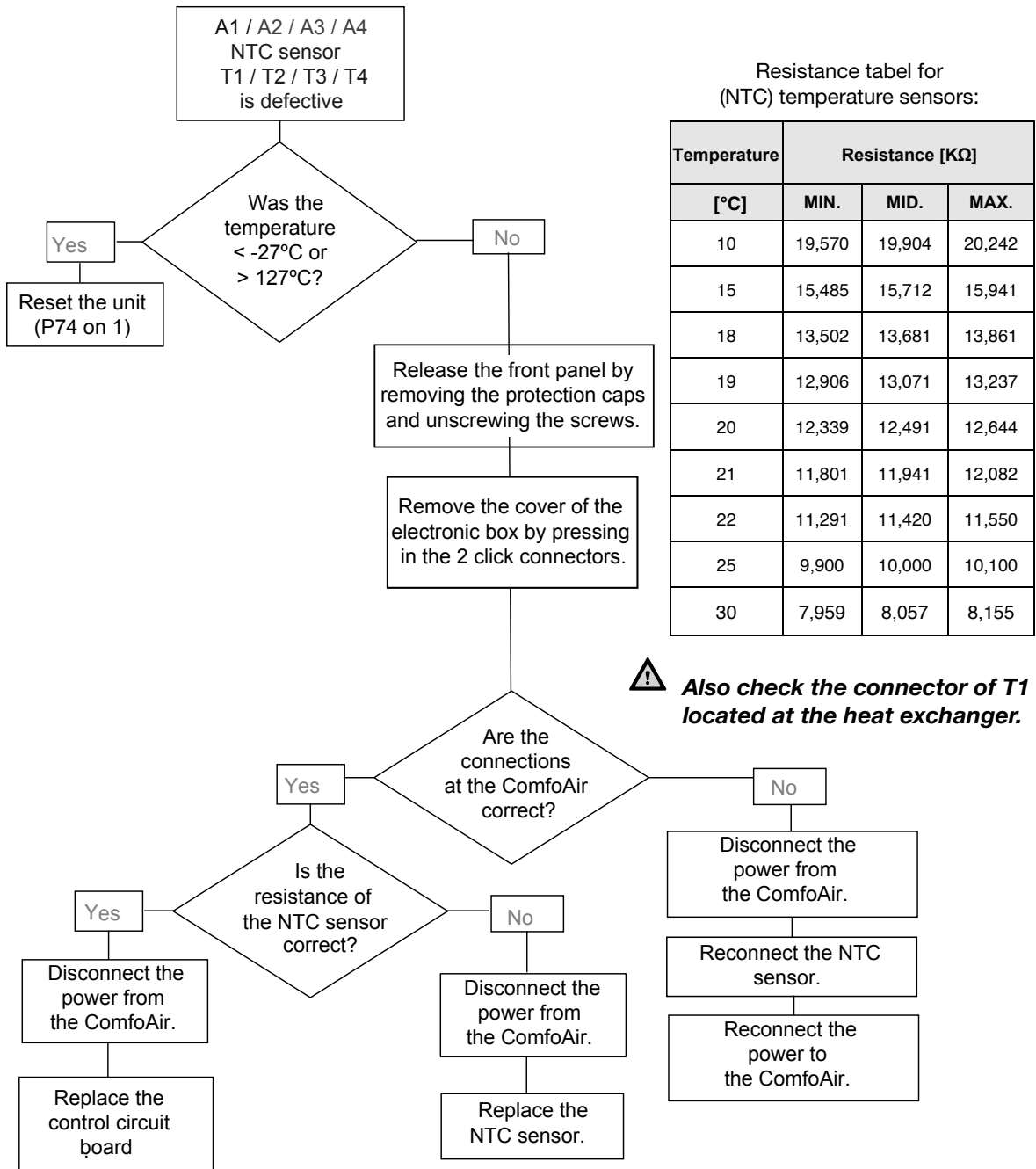



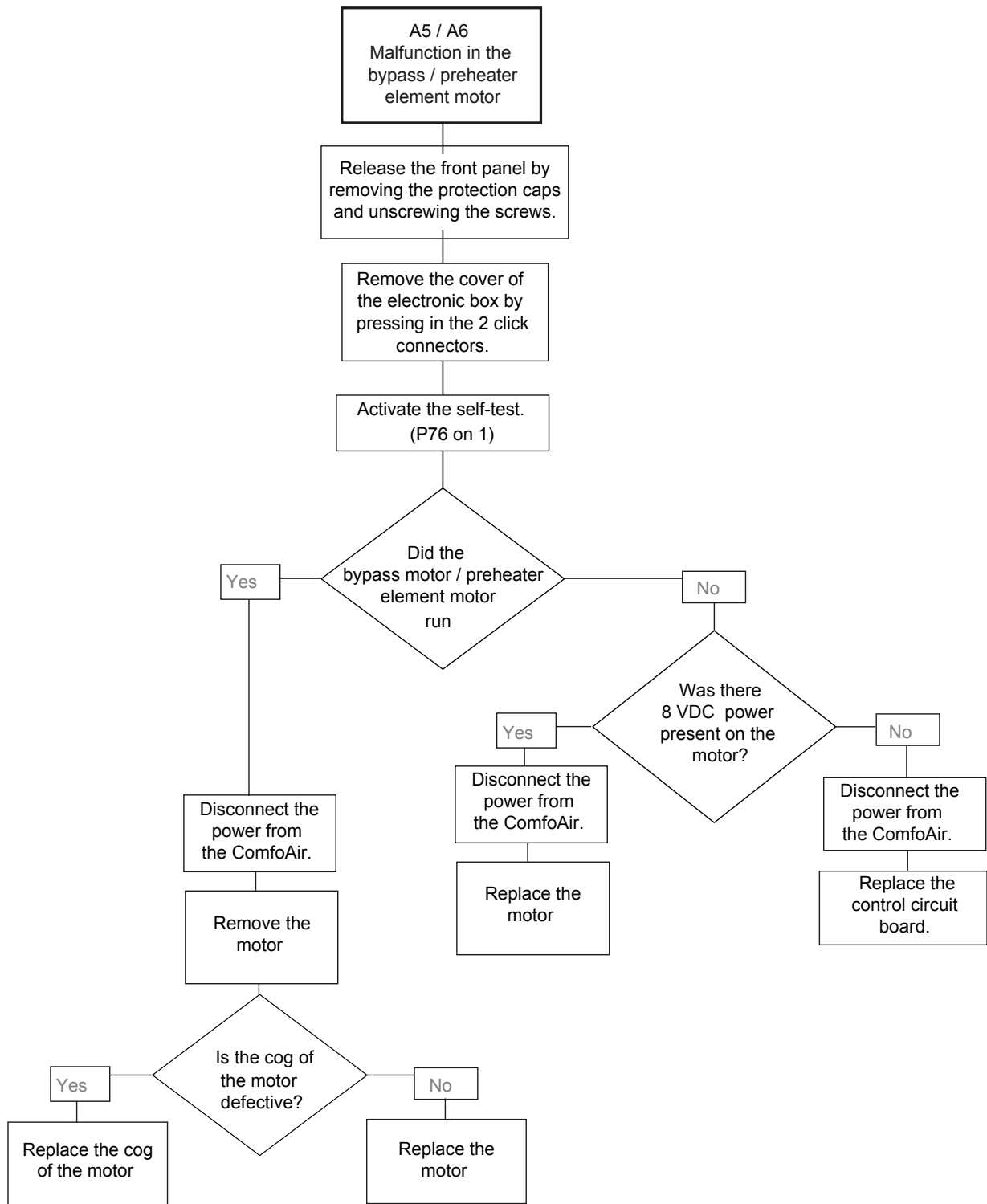

**☞ This error will appear when after 3 minutes of switching on the preheater element the temperature increase of T1 is less than 4°C. This can also happen when there is too much cold air passing the preheater element. In that case reduce the airflow and reset the unit (P74 on 1).**

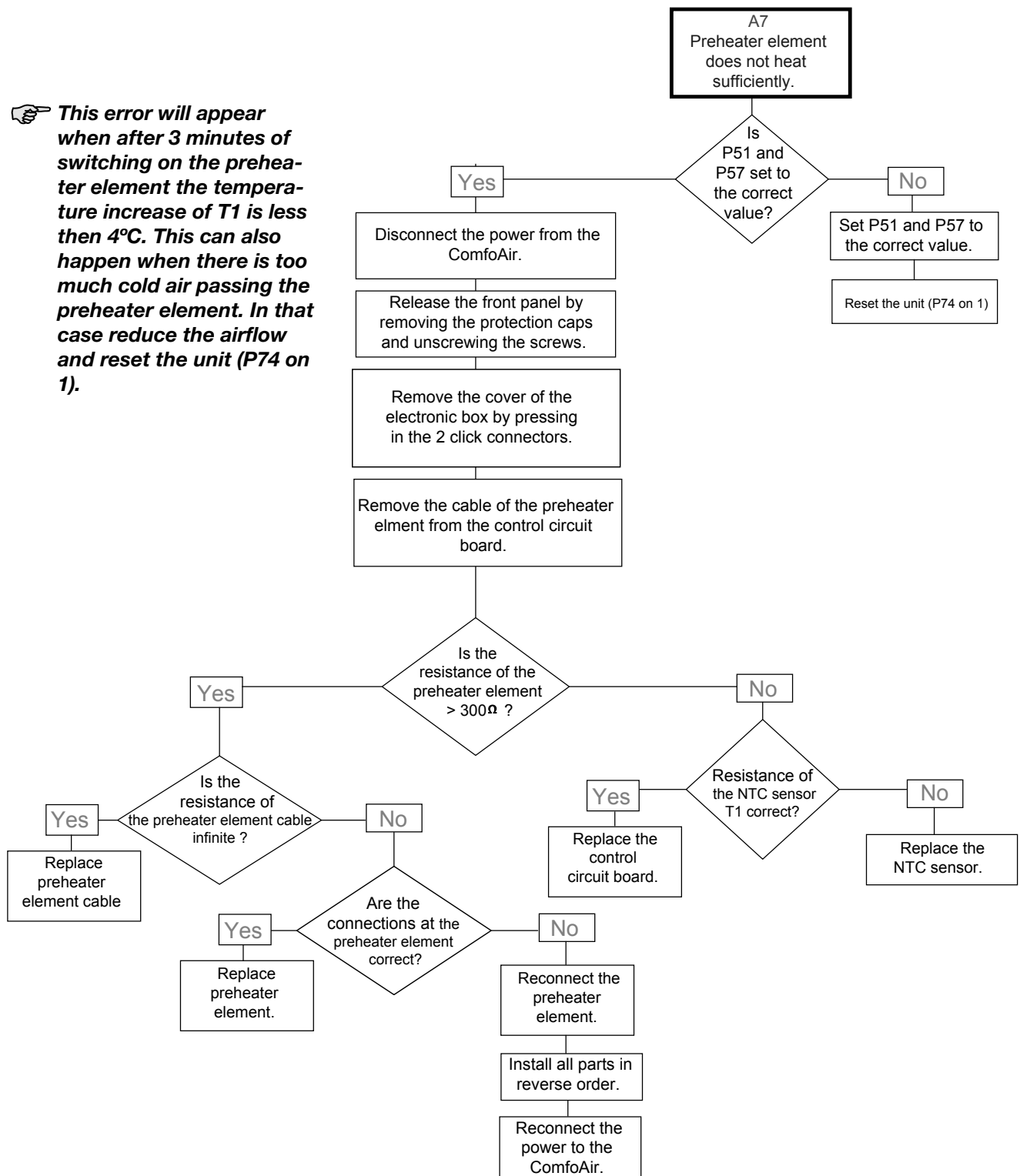

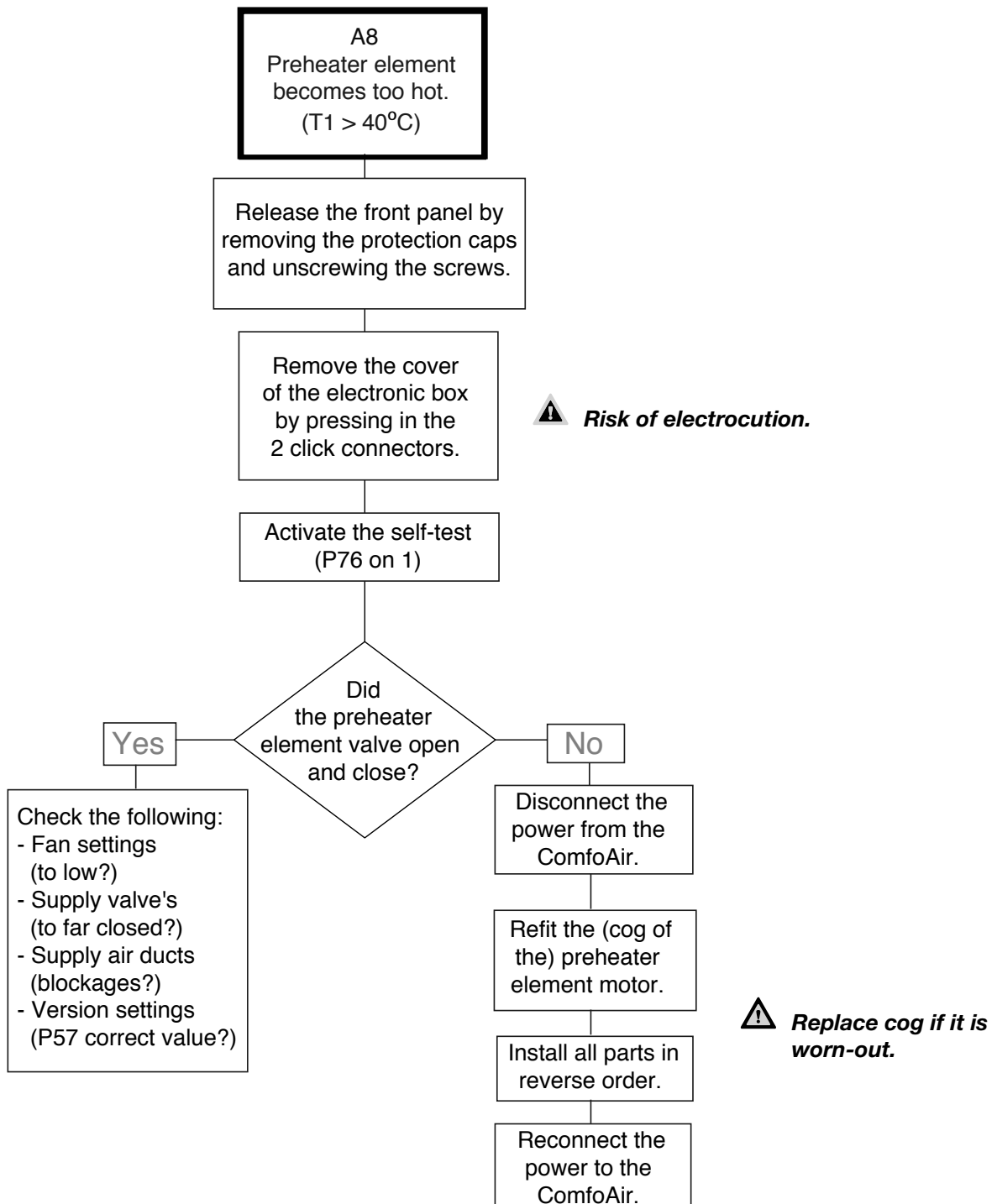

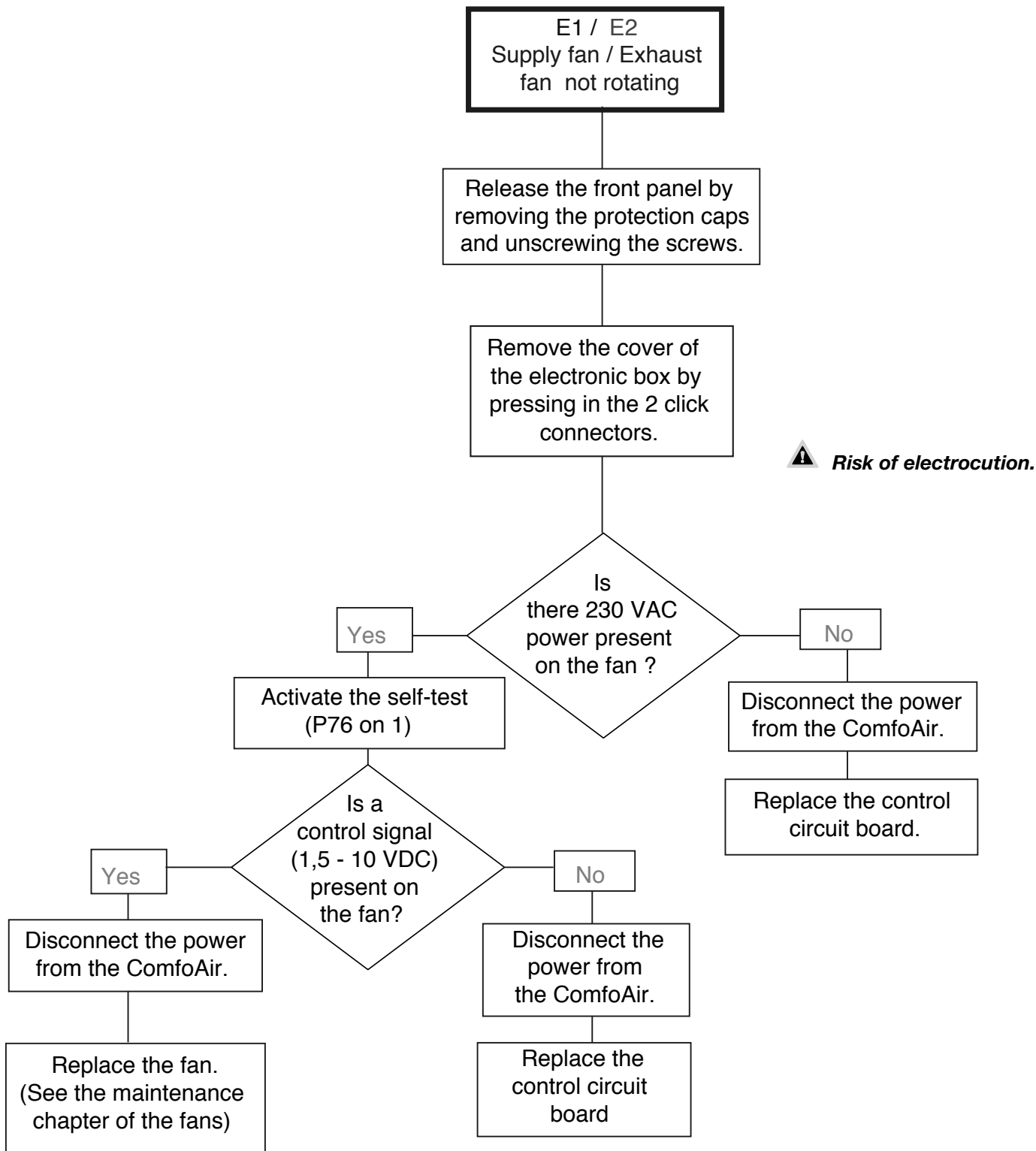

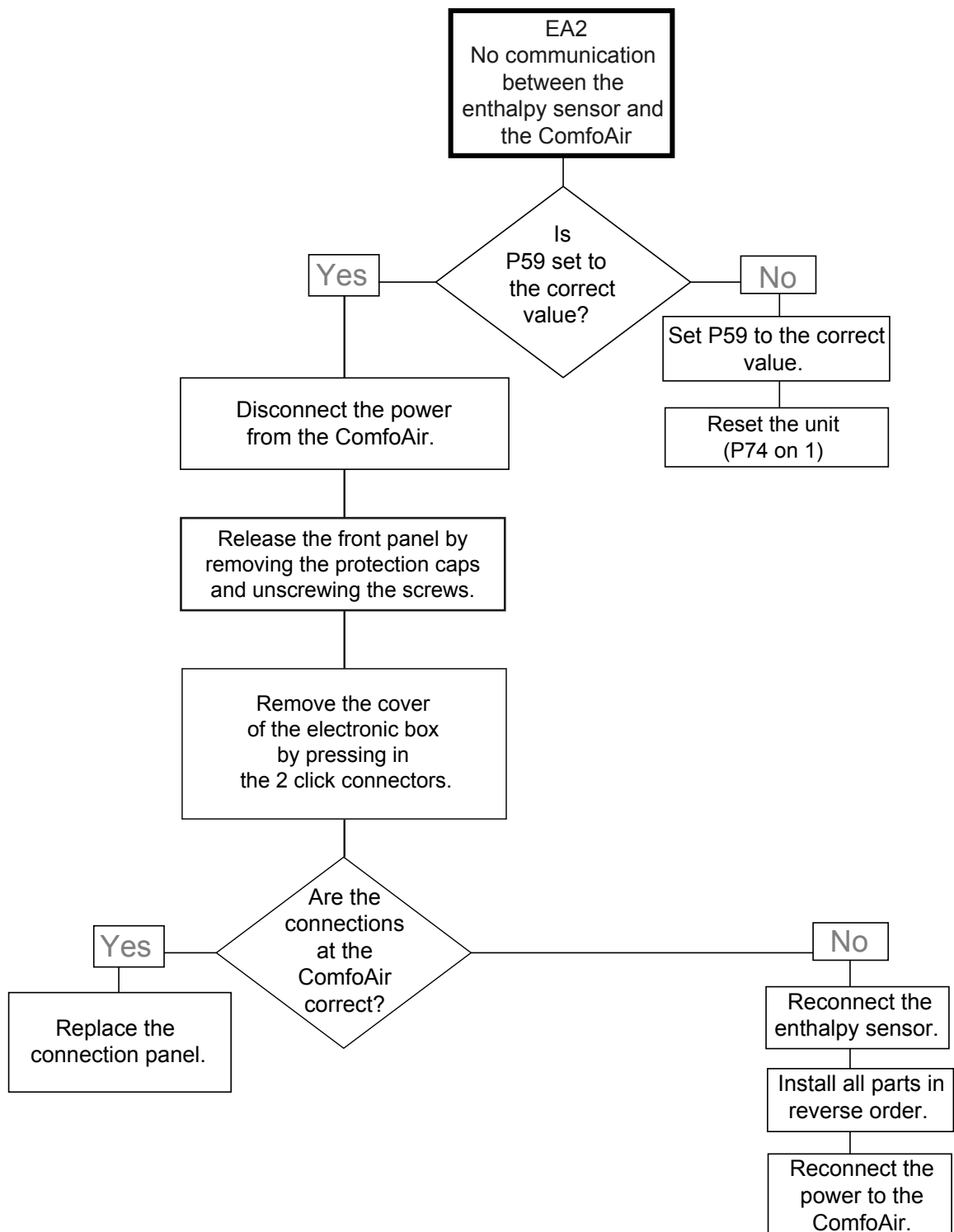

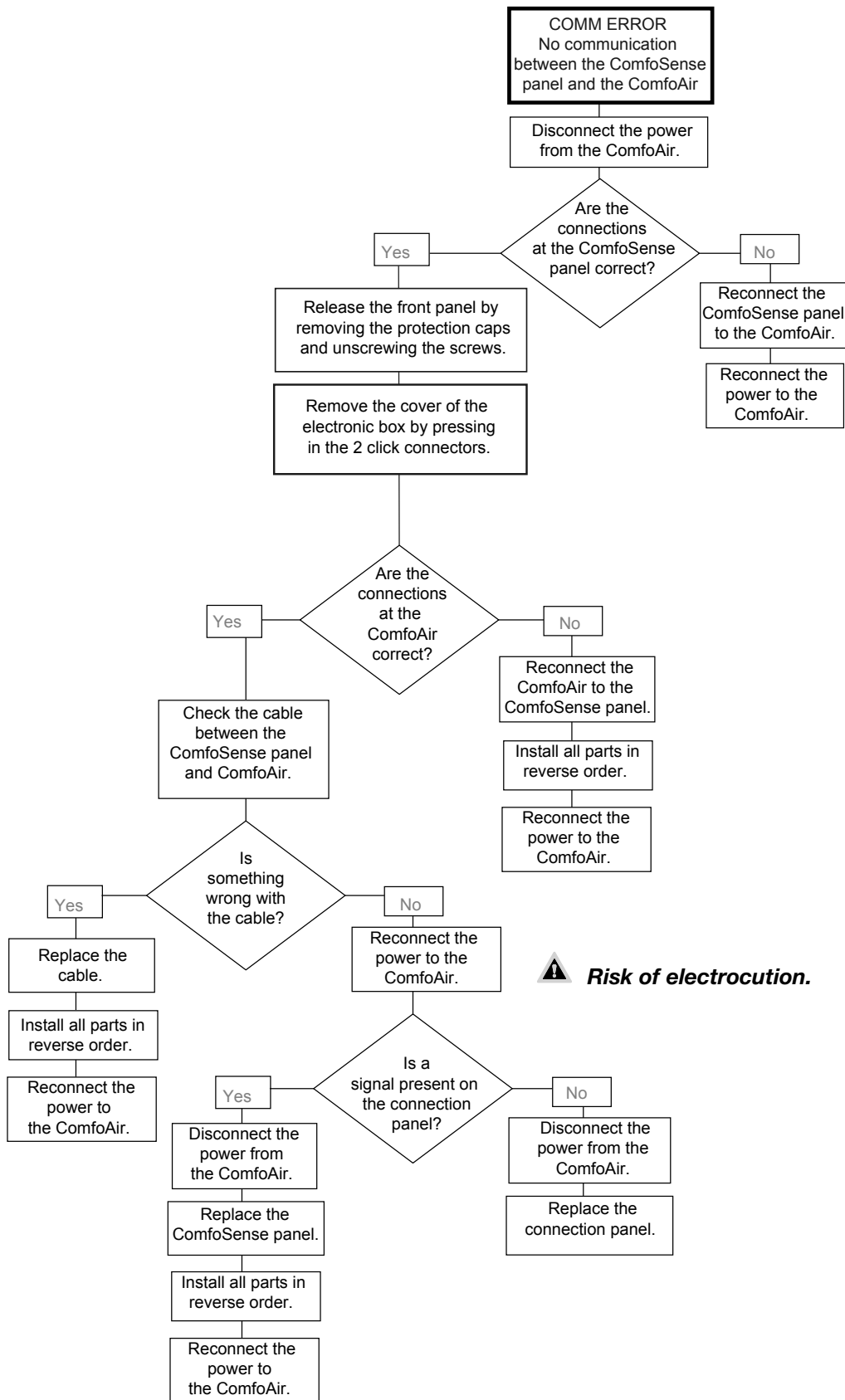

 **Risk of electrocution.**

**,Fil',tEr'  
Internal Filter is dirty**

**Press "OK" on the display for at least 4 seconds until the filter warning disappears.**

**Disconnect the power from the ComfoAir.**

**Remove the handles from the ComfoAir.**

**Remove the dirty filters from the ComfoAir.**

**Slide the clean (new) filters back into the ComfoAir.  
Cleaning: Vacuum the filters with a vacuum cleaner.**

**Refit the handles to the ComfoAir.**

**Reconnect the power to the ComfoAir.**

**FLTR  
Internal Filter is dirty**

**Press OK on the ComfoSense panel 2x to reset the FLTR warning.**

**Disconnect the power from the ComfoAir.**

**Remove the handles from the ComfoAir.**

**Remove the dirty filters from the ComfoAir.**

**Slide the clean (new) filters back into the ComfoAir.  
Cleaning: Vacuum the filters with a vacuum cleaner.**

**Refit the handles to the ComfoAir.**

**Reconnect the power to the ComfoAir.**

## 2.10.4 Malfunctions (or problems) without alerts

An overview of the malfunctions (or problems) without notifications is given below.

Problem/Malfunction	Indication	Check / action
System switched off	Power supply on	<b>Check the fuse on the control circuit board.</b> <ul style="list-style-type: none"> <li>• If the fuse is Defect, replace fuse.</li> <li>• If the fuse is OK, the control circuit board is defective and must be replaced.</li> </ul>
	No power supply	<b>Mains power</b> is off.
High intake temperature in summer	Bypass remains closed	<b>Reduce</b> the comfort temperature.
	ComfoAir is still in Winter mode: Bypass remains closed	Checking the Mode of the ComfoAir is possible with special read-out software. <ul style="list-style-type: none"> <li>• Wait until ComfoAir switches to Summer mode.</li> </ul>
Low intake temperature in winter	Bypass stays open	<b>Wait</b> a half hour, the bypass will always stay open for at least one half hour. After one half hour, increase the comfort temperature.
Little or no air supply; shower remains damp	Filters blocked	<b>Replace</b> the filters.
	Valves blocked	<b>Clean</b> the valves.
	Exchanger clogged by dirt.	<b>Clean</b> the exchanger.
	Exchanger frozen	<b>Defrost</b> the exchanger.
	Fan dirty	<b>Clean</b> the fan.
	Ventilation ducts blocked	<b>Clean</b> the ventilation ducts.
	ComfoAir is in frost-protection operation	Wait until the weather warms up.
Too noisy	Fan bearings defective	<b>Replace</b> the fan (bearings).
	Fan settings to high	<b>Change</b> the fan (settings).
	Slurping noise <ul style="list-style-type: none"> <li>• Siphon is empty</li> <li>• Siphon does not seal properly</li> </ul>	<b>Reconnect</b> the siphon.
	Whistling noise <ul style="list-style-type: none"> <li>• An air gap somewhere</li> </ul>	<b>Seal</b> the air gap.
	Airflow noise <ul style="list-style-type: none"> <li>• Valves do not close onto duct.</li> <li>• Valves not open far enough</li> </ul>	<b>Reinstall</b> the valves. <b>Reset</b> the valves.
	Condensation leak	<b>Unblock</b> the condensation drain.
Condensation leak	Condensation drain clogged	<b>Unblock</b> the condensation drain.
	Condensation from exhaust duct does not run into leakage tray	<b>Check</b> whether the connections are correct.
Corded 3-position switch not working	Cabling is not correct	<b>Check</b> the wire-circuit of the 3-position switch by measuring the voltage: <ul style="list-style-type: none"> <li>• Voltage only on N &amp; L3: [Fans rotate in position 1].</li> <li>• Voltage only on N &amp; L3 &amp; L2: [Fans rotate in position 2].</li> <li>• Voltage only on N &amp; L3 &amp; L1 or N &amp; L3 &amp; L2 &amp; L1: [Fans rotate in position 3].</li> </ul>
	Switch is defective	
Wireless 3-position switch not working	Battery is discharged	<b>Check</b> the battery. <ul style="list-style-type: none"> <li>• <b>Replace</b> the battery (if necessary).</li> </ul>
	Switch is not correctly tuned.	Remove the power shortly from the ComfoAir. Shortly after reconnecting the power tune the switch again.



## 2.11 Service parts

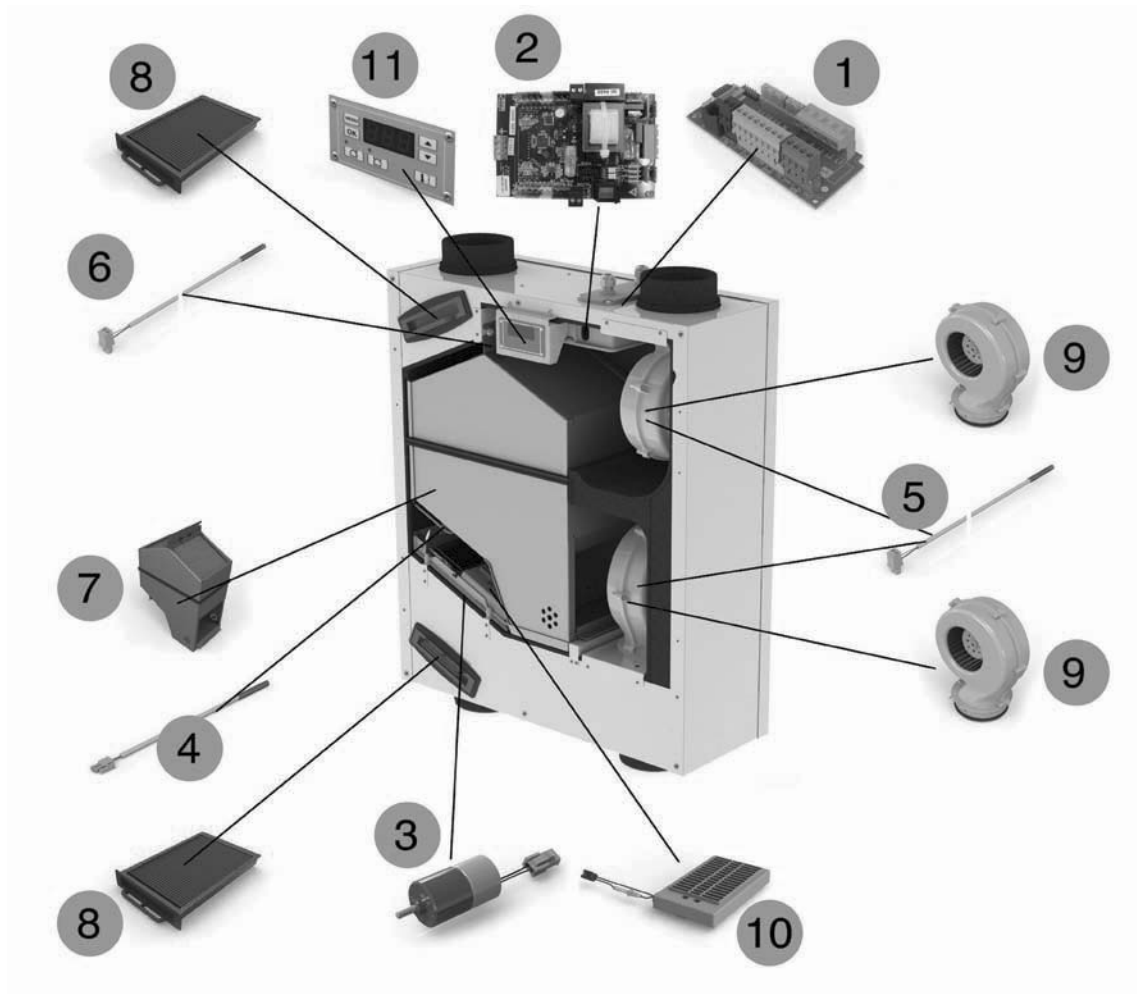

The following table contains an overview of the spare parts available for the ComfoAir.

Number	Part	Article number
1	Connection PCB	400300068
2	Control PCB	400300067
3	Bypass / Preheater motor	400200023
4	Temperature sensor T1	400300063
5	Temperature sensor T2 / T4	400300063
6	Temperature sensor T3	400300063
7	Heat exchanger	400400036
7	Enthalpy exchanger	400400037
8	Filter set G4 (2x)	400100023
9	Fan	400200025
10	Preheater	400300069
11	Display	400300062

## 2.12 Wiring diagram: ComfoAir 160

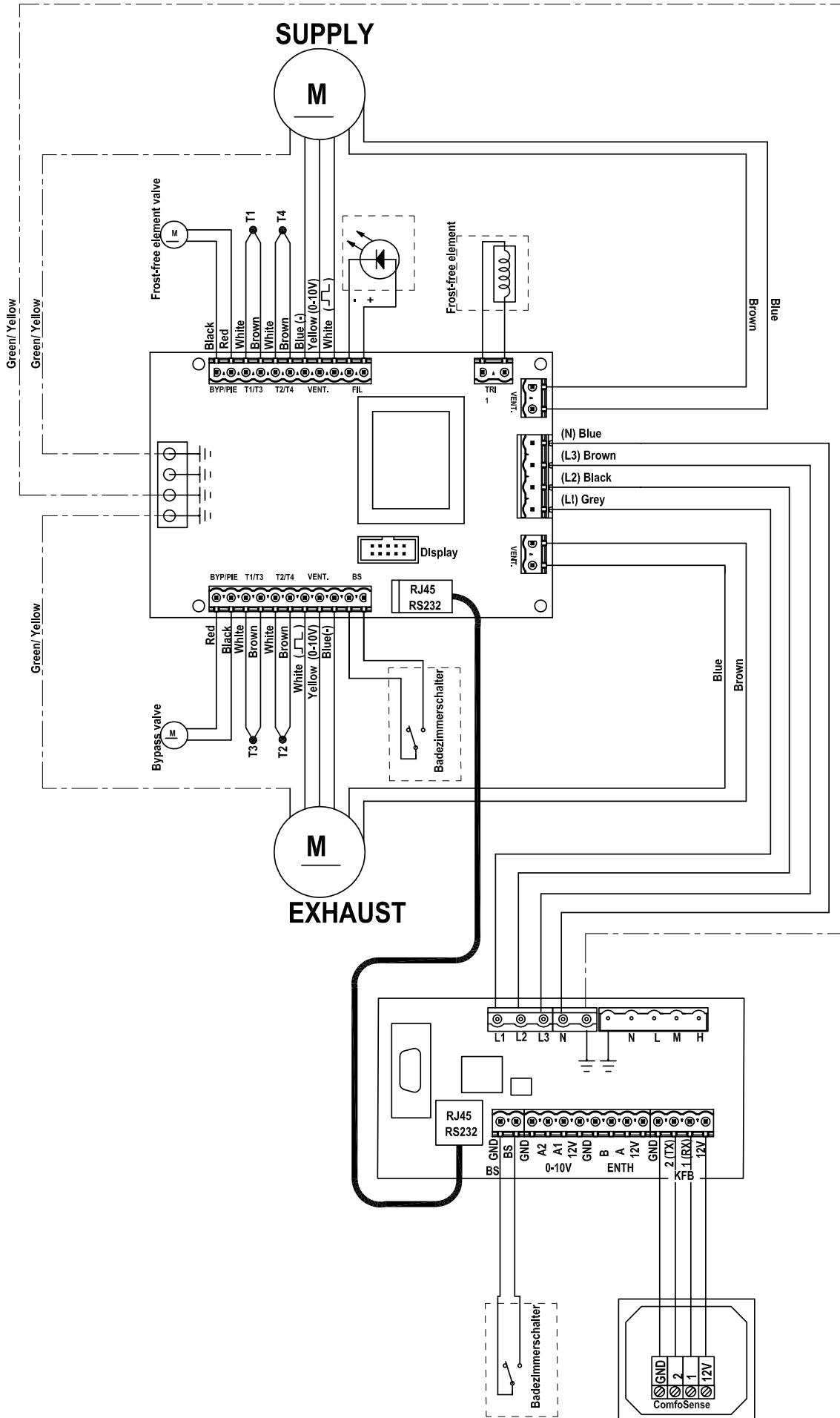

## 2.13 EEC declaration of conformity

Zehnder Group Nederland B.V.  
Lingenstraat 2  
8028 PM Zwolle-NL  
Tel.: +31 (0)38-4296911  
Fax: +31 (0)38-4225694  
Company register Zwolle 05022293

### EEC declaration of conformity

#### Machine description

: Heat recovery units: ComfoAir 160 series

#### Complies with the following directives

: Machinery Directive (2006/42/EEC)  
Low Voltage Directive (2006/95/EEC)  
EMC Directive (2004/108/EEC)

Zwolle, 15-01-2014  
Zehnder Group Nederland B.V.



O. Schulte,  
Director Production Zwolle

**zehnder**

**Zehnder Group Italia S.r.l.**  
Via XXV Luglio, 6  
I - 41011 Campogalliano (MO)  
Tel.: +39 (0)59 9786200  
Fax: +39 (0)59 9786201  
Internet: [www.comfosystems.it](http://www.comfosystems.it)  
E-mail: [info@comfosystems.it](mailto:info@comfosystems.it)